

EP-021 Series 握柄把手 Grab Handle

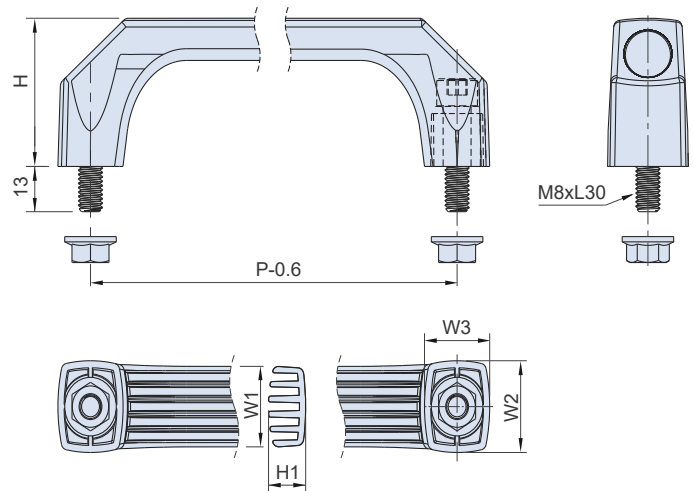

材質與表面處理

■ 材質：尼龍(PA66+GF)。

配件包 Screws pack

特徵

- 安裝迅速·從外向板面固定螺絲·板面可植入螺母或攻牙。
- 耐酸鹼·耐油·耐熱150°C·耐寒-20°C。
- 材料符合UL94 HB防火等級。
- 配件包：兩根M8*30mm螺絲·兩顆螺帽。

MATERIAL AND FINISH

■ Nylon(PA66+GF).

FEATURES

- Could be quick installed on the panel with a tapped hole or with a normal hole (by nut), and tight the screw from outside.
- Working temperature: -20°C to 150°C.
- Resistance to acid, alkali, greasiness.
- Use the original raw material compliant with UL94 HB standards.
- Optional screws pack: Screws M8*30mm 2pcs, and nuts 2pcs.

SPECIFICATION:

Unit:mm

產品編號 Item no.	配件 Screws pack	顏色 Color	尺寸 Dimensions							荷重 Load Capacity(kgf)	重量 Weight(g)
			P	H	H1	W1	W2	W3			
EP-02120B	有配件包 With screws pack	黑 Black	120	42	12	23	26	21	80	90	
EP-02150B			150	51	13	23.5	28	23		115	
EP-02180B			180	50	15	25	30	25		130	
EP-02120R		橘 Orange	120	42	12	23	26	21		90	
EP-02150R			150	51	13	23.5	28	23		115	
EP-02180R			180	50	15	25	30	25		130	
EP-022120B	無配件包 Without screws pack	黑 Black	120	42	12	23	26	21		48	
EP-022150B			150	51	13	23.5	28	23		73	
EP-022180B			180	50	15	25	30	25		88	
EP-022120R		橘 Orange	120	42	12	23	26	21		48	
EP-022150R			150	51	13	23.5	28	23		73	
EP-022180R			180	50	15	25	30	25		88	

ES-3716 Series 握柄把手 Grab Handle

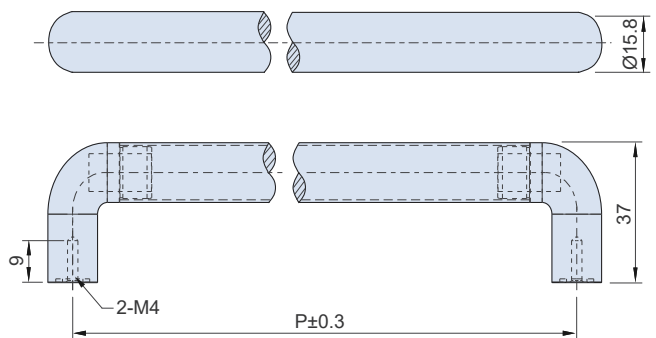

材質與表面處理

- 1. 手把：不銹鋼(SUS304)·毛絲面。
- 2. 固定座：鋅合金·鍍鉻。

MATERIAL AND FINISH

- 1.Handle: Stainless steel(SUS304), Brushed Finish.
- 2.Holder: Zinc alloy, Chrome plated.

SPECIFICATION:

Unit:mm

產品編號 Item No.	P	荷重 Load Capacity(kgf)	重量 Weight(g)
ES-3716130	130	50	118
ES-3716160	160		122
ES-3716200	200		133